

Tablet and Cradle Installation

Cradle Kits are referenced by the size of the case included. The only difference in the kits, from model to model, is the case size (case is updated as tablet size changes).



Tablet
(sold separate from Cradle Kit)



Tablet/Cradle Assembly
(shown with Tablet preinstalled)

Cradle Kits

To order a replacement kit (or a case for an existing tablet), match tablet size to case size shown in table below.

Tablet Size	Cradle Kit w/Case (size shown; newest to oldest)	DF Part Number	Case Only (size shown)	DF Part Number
8.7" Tablet	Cradle Kit, Tab A7, 8.7"	CRADLE-KIT-A7-8-7	Case, Tab A 8.7"	CASE-TABLET-TAB-A-8-7
8.4" Tablet	Cradle Kit, Tab A, 8.4"	CRADLE-TAB-A	Case, Tab A 8.4"	CASE-TABLET-TAB-A-8-4
8.0" Tablet	Cradle Kit, Tab A, 8.0"	DF-INV-028		
	Cradle Kit, No Case	CRADLE-NO-CASE		

Items Included in the Kit

Unpack the kit and review its contents. Cradle parts are shipped preassembled. If a Digital Fleet Tablet is purchased in addition to the Cradle Kit, it comes preassembled with the kit (DF Tablet sold separately).

Cradle Kit Parts Breakdown (Images shown for general parts reference only.)

Cradle with 4" Mount Arm



Tablet Case (style may vary per Kit Model)

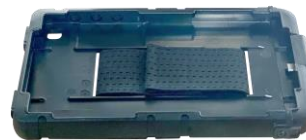

To order a replacement Case, reference DP Part Number in table above (match Case size to Tablet size).

Cradle Power Cable, Female USB to 12v—kit includes **either** a 3 wire or 2 wire cable. DF Replacement Part Number: [CRADLE-USB-PWR-CABLE](#)



3 Wire Cable

OR

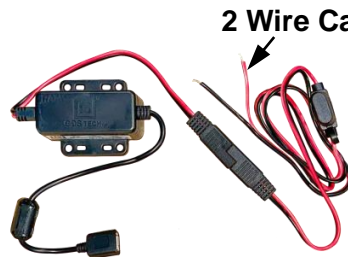

2 Wire Cable

Charger, Case Magnetic to USB

DF Replacement Part No.: [CASE-MAGNETIC-CHARGER-USB](#)



4" Mount Arm



Ball Mount



Hardware Pack



Keys



Optional Parts (available for purchase separately)

6" Mount Arm Only
DF Part Number: **MOUNT-ARM-6INCH**



Extends 2" farther than a standard arm (brings the tablet closer to the driver when it is mounted farther away).

Backing Plate, Cradle Dash Mount
DF Part Number: **CRADLE-BACKING-PLATE**



Metal plate used to support the Ball Mount on the interior side of the dash.

Tools for the Job (not included)

- Screw gun with Phillips end
- Wire crimpers
- Wire strippers
- Side cutters

Additional Items Needed (not included)

- Grommets, bushings (to pass wiring through dash)
- Wire ties (additional, if needed)
- Drill w/drill bits (if optional plate is used)

Installation – Tablet and Cradle

The Tablet and Cradle Assembly is typically installed on the dash of the truck in a convenient location for use. The cradle is connected to truck power and is responsible for charging the tablet.

During Installation You Will:

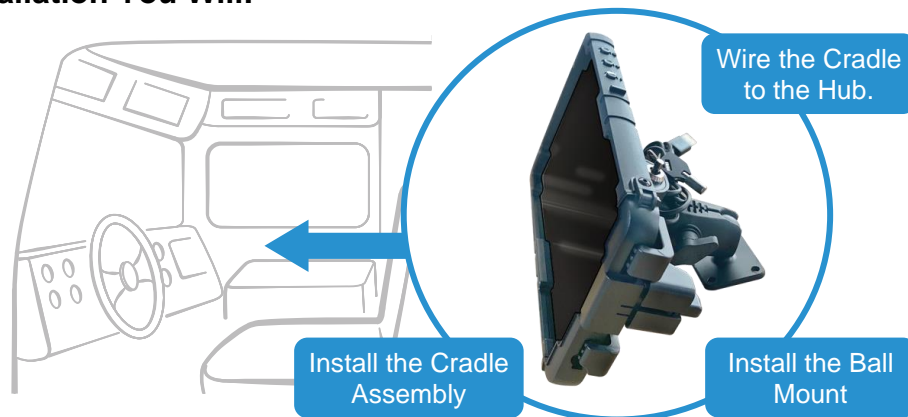

Tablet and Cradle Assembly

The tablet (if ordered from DF), case, and cradle come preassembled to the ball mount. Use the steps below to reassemble any parts removed or to install an existing tablet, if applicable.

Step 1. Insert Tablet into Case (a two-piece hard plastic shell fastened with two hex screws):

Open case to add or remove the tablet—remove hex screws to open case.

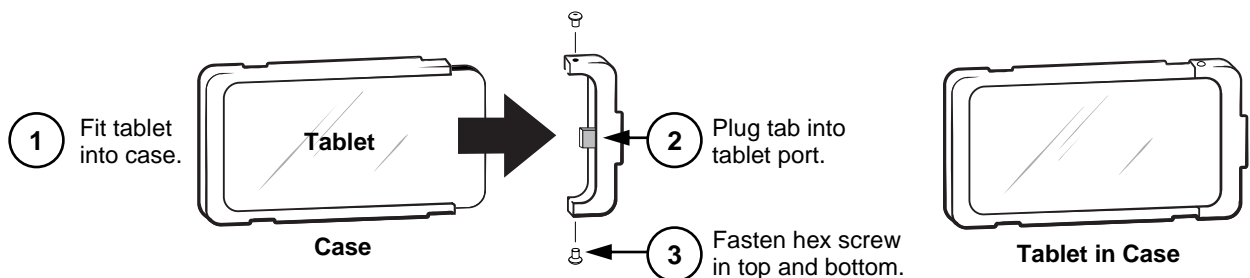

Step 2. Insert Case into Cradle.

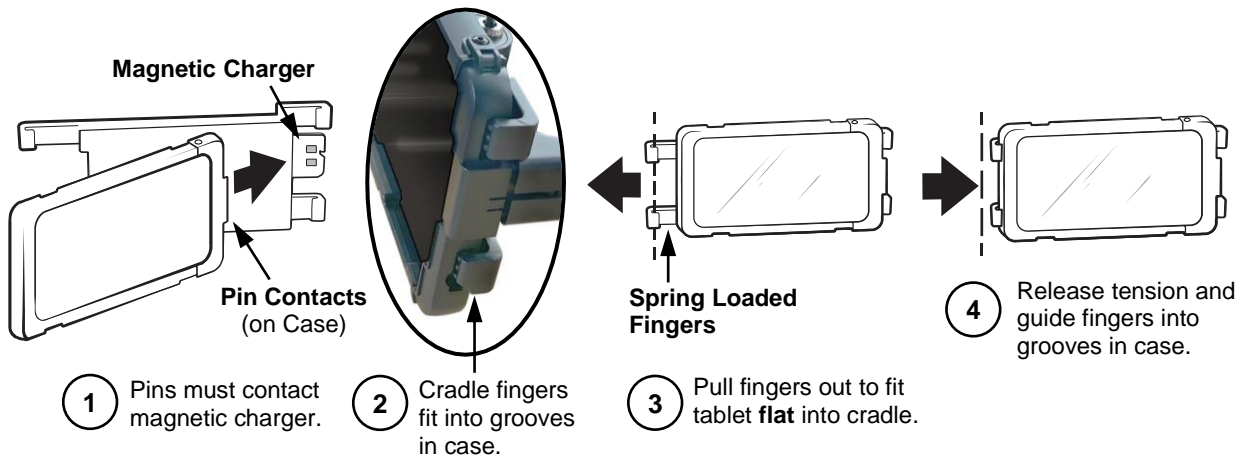

Step 3. Install Pedestal on Ball Mount.

To readjust cradle position, **loosen** knob slightly, then retighten after adjustment.

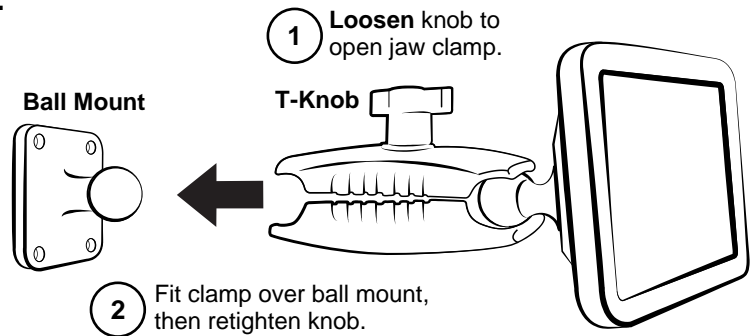

Step 4. Lock Tablet in Cradle.

Press the lock button down to lock the tablet in the cradle—a key is required to unlock the cradle.

Follow your company policy to determine if the tablet is to be locked in the cradle and where keys are maintained.



Cradle Installation

Step 1. Locate a Tablet Cradle mount position:

Typical mounting position is on the dash or overhead panel—location may vary depending on chassis style. (Dash mount shown for general installation reference).

If using an existing ball mount, skip to Step 5.

- 1.1. Hold assembled cradle and mount in place to test for a good location **before** fastening the ball mount.

Check the following:

- Tablet must not interfere with truck functions.
- Is there a place to mount the ball bracket?
- Is tablet easy see; comfortable to reach?

- 1.2. Mark the mounting hole locations.

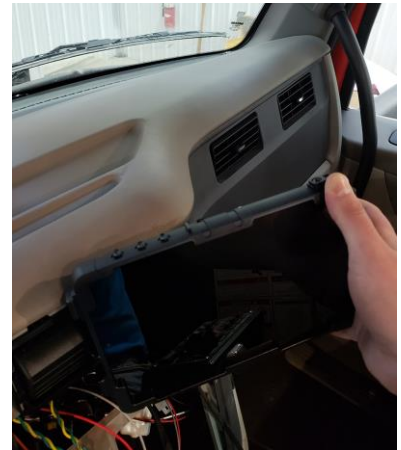

Step 2. **Before installation**, check the mounting location **inside** the dash.

Make sure the self-tapping mounting screws will not damage any parts or wiring in the dash.

If truck is older or does not have a sturdy mounting surface, an optional metal backing plate is available for purchase separately (PN: CRADLE-BACKING-PLATE)

- Plate fits inside dash to reinforce ball mount.
- Mounting holes in plate match holes in ball bracket (typically holes in plate are threaded; screws included).
- Pre-drill mounting holes in dash (screws are not self-tapping).

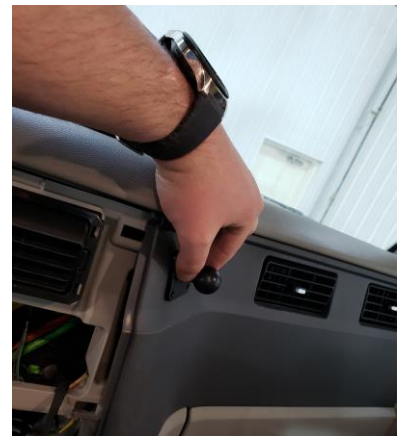
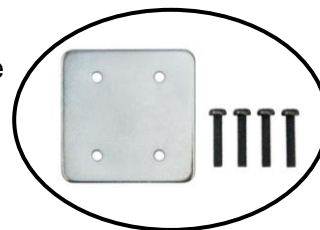

Step 3. Remove dash mount from pedestal arm (loosen T-Knob to open clamp).

Step 4. Screw mount to dash.

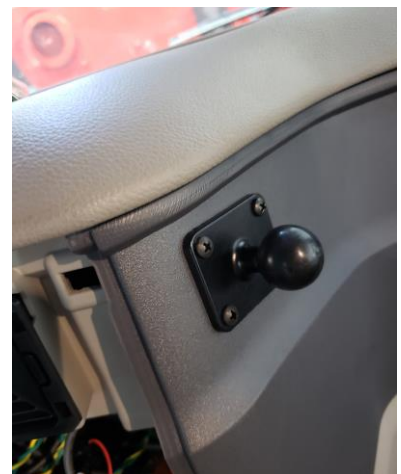

Step 5. Wire USB Converter to Hub (use same steps to wire a preinstalled cradle to the DF+ Hub).

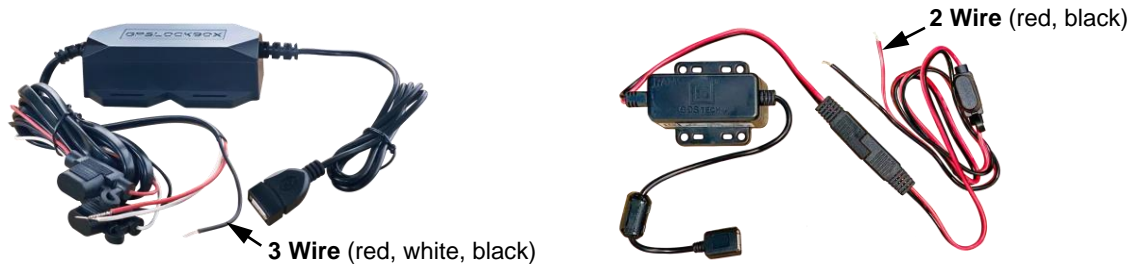

- 5.1. **Add a female terminal to power wire connection** (see applicable wire type below):
2 Wire: Cut soldered end off red power wire, strip end, then crimp on a female terminal.
3 Wire: Connect red and white power wires with a female terminal, as shown below.

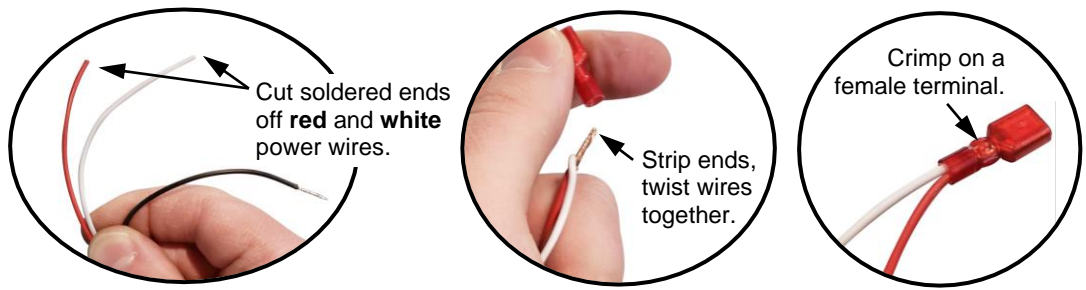

- 5.2. Crimp a female terminal on **black** (ground) wire end.

- 5.3. Plug power and ground wires to Hub as shown below, also see alternate connection information.

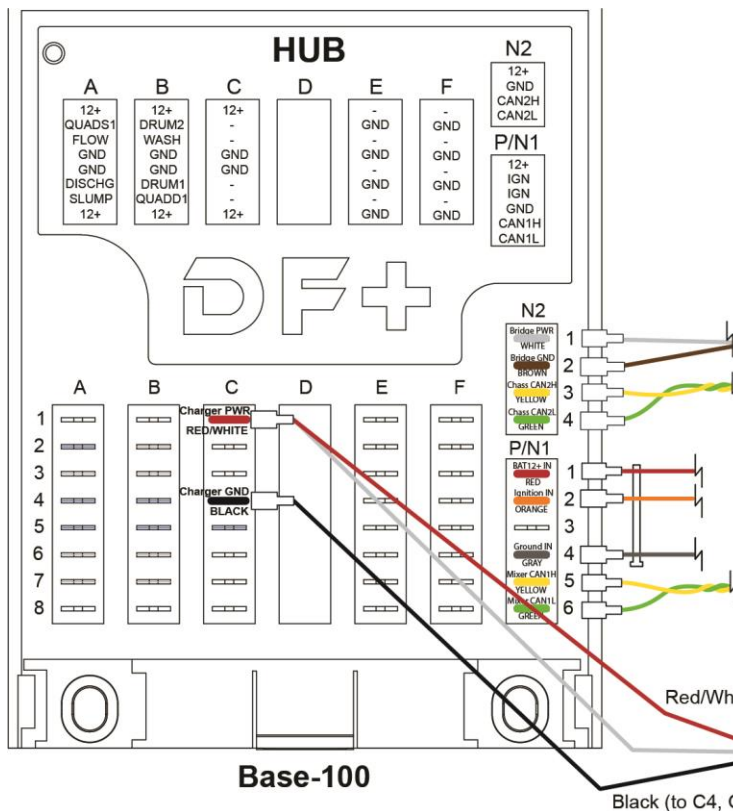
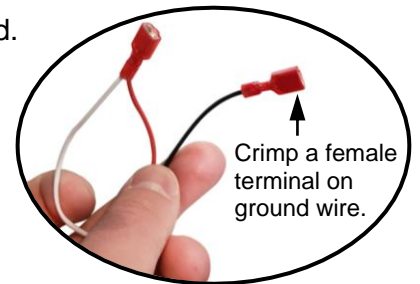

Alternate Connection Notes:

HUB Wiring view shows the typical 3 Wire Connector Harness for general wiring reference.

- **For a 2 Wire Harness**, connect red wire to C1 (12v Power) black wire to C4 (ground).
- **For a truck without a Hub**, connect USB Harness wires directly to chassis constant power and ground (refer to the Chassis CAN and Power Connections section to find these typical locations in your truck).

Step 6. 2 Wire Connector Harness, make sure plug ends are securely connected, see image.

3 Wire Connector Harness, skip to Step 7.

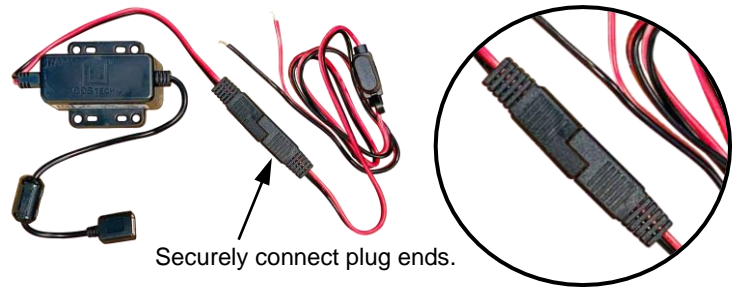

Step 7. Plug USB cables together. Tablet will show a charging icon/give audible indicator verifying the cradle is connected and working.

Use a tie strap to keep the connection together. This helps prevent the driver from pulling the USB connection apart.

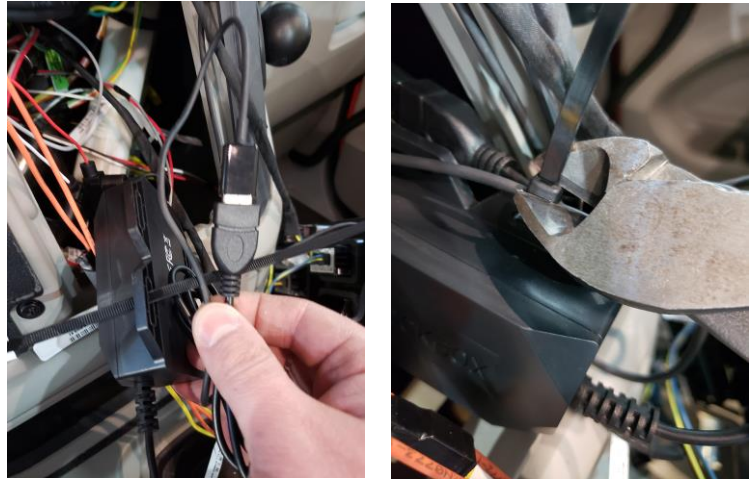

Step 8. Place the power unit and USB cable/connection inside the dash.

If a location other than the dash is used, make sure the wiring and power unit are neatly wire tied together and placed in a protected location.

Step 9. Route cable under dash trim or through an existing hole in the dash.

Step 10. Install cradle and pedestal on ball mount, then lock tablet in cradle, if applicable (see Tablet and Cradle Assembly section).

Step 11. Leave enough slack in cable for driver to make tablet adjustments, then tuck the remaining wiring in the dash.

Step 12. Use a tie strap to fasten the charger USB cable to the pedestal as shown—allow enough slack for tablet adjustment.

Step 13. Close dash when installation is complete.

Step 14. Verify the tablet is connected and functioning properly, reference the DF+ Verification Instructions for the tablet.

For installation or troubleshooting questions, please call DF+ Support at 630.518.4606.

